



**OWNER'S MANUAL**  
**600.4 EVO5**

Introduction.....	3
Package contents .....	3
Safety instructions .....	4
Assembling and Disassembling the plastic cover.....	5
Panels description	
Audio inputs and controls .....	6
Power inputs and audio outputs.....	7
Electrical Dimensioning.....	8
Audio inputs .....	8
Installation sequence.....	9
Wiring diagram	
Four channels wiring diagram.....	10
Three channels wiring diagram .....	10
Two channels wiring diagram .....	11
Gain adjustment procedure.....	11
Crossovers set up .....	12
Technical specifications	
Parameters .....	13
Dimensional data.....	13

**DEAR CUSTOMER,****CONGRATULATIONS ON ACQUIRING A PRODUCT WITH THE HIGHEST QUALITY AND TECHNOLOGY!**

You have just purchased a *SounDigital* product of the highest technology and quality, so we thank you for your confidence.

**Class D Amplifiers:**

Class D amplifiers have as main characteristics the audio quality, efficiency, application versatility and compact design. Following are the advantages of these features:

**Audio Quality** – In the past, Class D products had limited response and for higher frequencies, Class AB products performed better, but their efficiency was very low. The new technologies introduced by SounDigital resulted in a Class D amplifier with high efficiency and superior Class AB performance.

**Efficiency** – SounDigital Class D amplifiers have total efficiency (output + power source) greater than 70%, which guarantees lower battery consumption and less heating.

**Application Versatility** – The flat full-frequency response of SounDigital amplifiers allows them to be used in all car sound systems. Meeting the demands with extreme quality.

**Compact Design** – The high efficiency and high technology applied, allows SounDigital amplifiers to be very compact, facilitating installation in vehicles where space is limited.

**IMPORTANT INFORMATIONS**

On this manual you will learn about the product, its features and characteristics, in order to obtain the best result and to be able to enjoy your music with *SounDigital* quality and power.

To better understand and take advantage of all the functions of the product and use it safely, read this manual carefully and if you have any questions, consult our support by email **info@soundigitalusa.com**.

**PACKAGE CONTENTS**

- 01 **600.4 EVO5** Amplifier
- 01 Installation quick guide with warranty card
- 01 Promotional sticker

To prevent injuries to the user or damage to the amplifier, read all safety instructions written on this manual;

If you are insecure about the installation of this equipment, get in touch with our tech support or with a professional specialized in car audio installation;

Before proceeding with the installation of any electric equipment on your vehicle, unplug the negative (-) terminal of the battery to avoid fires, injuries or damages;

Use your sound system safely. The continuous exposure to sound pressures over 85dB may cause irreversible hearing damage;

This equipment is for use in automotive DC voltage batteries between 12.6 and 14.4 volts. Before installing the equipment, check voltage of the batteries;

Do not install the amplifier in places exposed to water, dirt or humidity;

Choose a ventilated place to install the amplifier and avoid blocking the side ventilation windows;

Mount the amplifier in a secure way. Avoid mounting it on metallic parts of the vehicle, because it may cause ground looping (noise);

Make sure that the location chosen for the amplifier installation does not effect the operation of the vehicle;

When passing cables through metallic walls, use rubber O-rings to avoid cable cutting and short-circuits;

Clean the amplifier periodically with brush or dry cloth to assure the thermal efficiency of the heatsink;

This product may reach temperatures over 60°C/140°F. Make sure it is cold before touching it;

Be careful when making holes in the vehicle. Make sure you are not making holes in the fuel tank, brake lines or electrical cables of the vehicle;

Make sure the cables are properly secured throughout the installation;

Wear gloves, safety glasses and and all necessary PPE during the installation of SounDigital amplifiers.



**Warning!**

THIS "WARNING" SIGN ALERTS THE USER OF IMPORTANT INFO. NOT FOLLOWING THIS INSTRUCTIONS MAY CAUSE INJURIES TO THE USER OR DAMAGE TO THE EQUIPMENT.

The plastic covers have the function of finishing and hiding the amplifier fixing screws. To disassembling and assembling them, follow the instructions below.

### DISASSEMBLING OF THE PLASTIC COVER

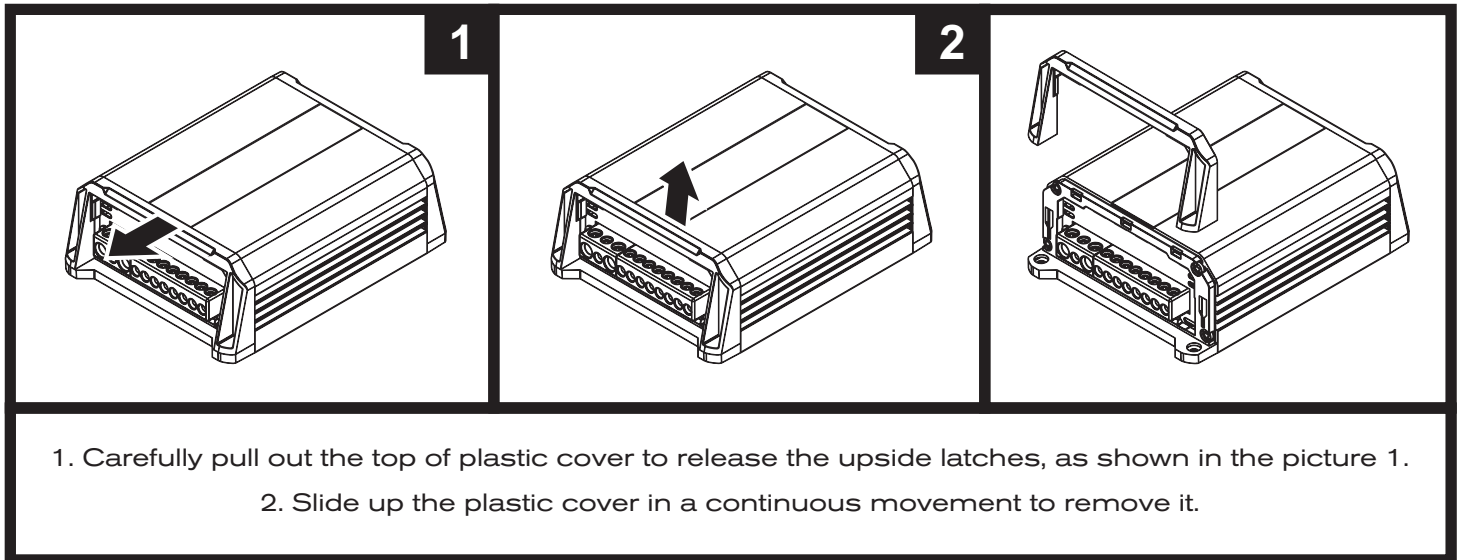

\*Merely illustrative images.

### ASSEMBLING THE PLASTIC COVER

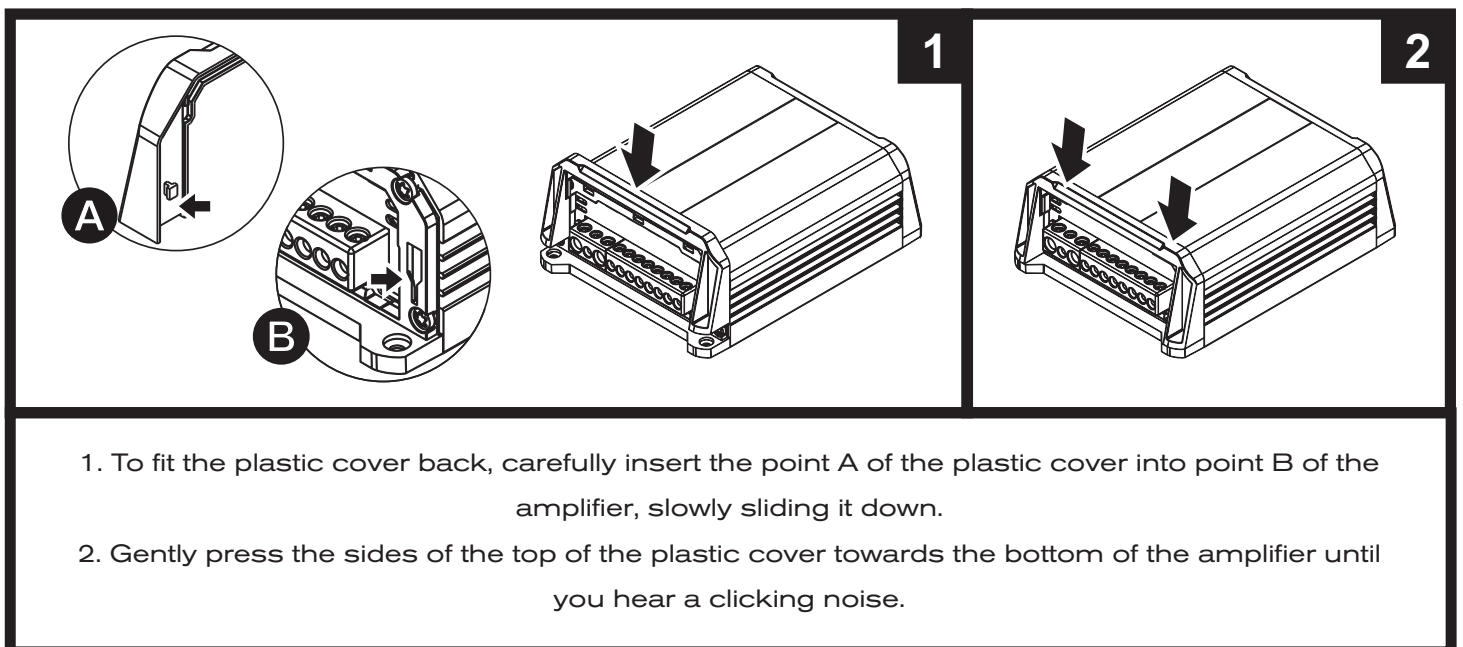

\*Merely illustrative images.

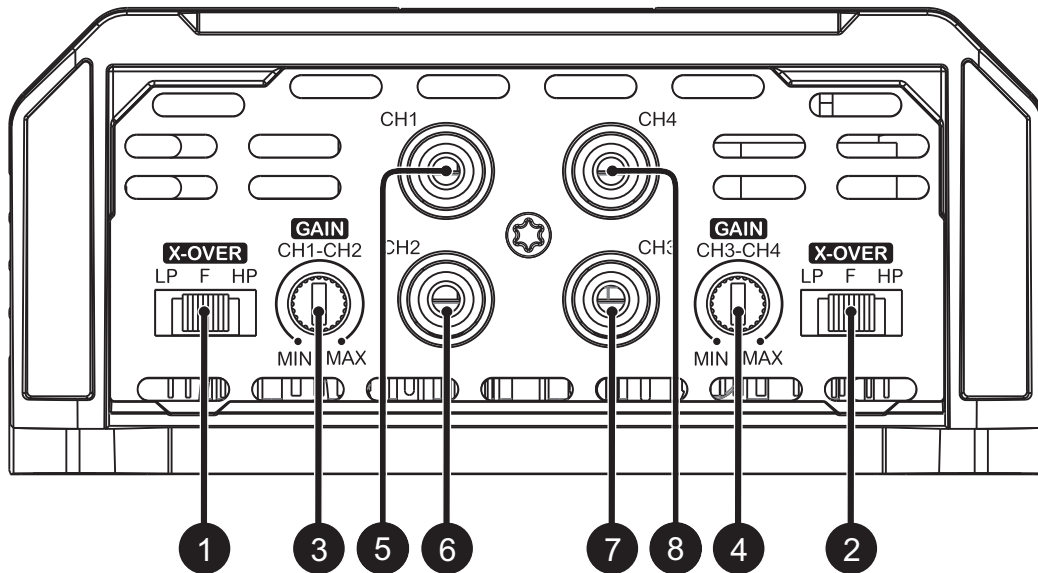

1	CH1/CH2	Crossover Switch
2	CH3/CH4	Low Pass - Full - High Pass
3	CH1/CH2	Variable Gain Control
4	CH3/CH4	
5	CH1	Audio inputs - RCA connectors
6	CH2	
7	CH3	
8	CH4	

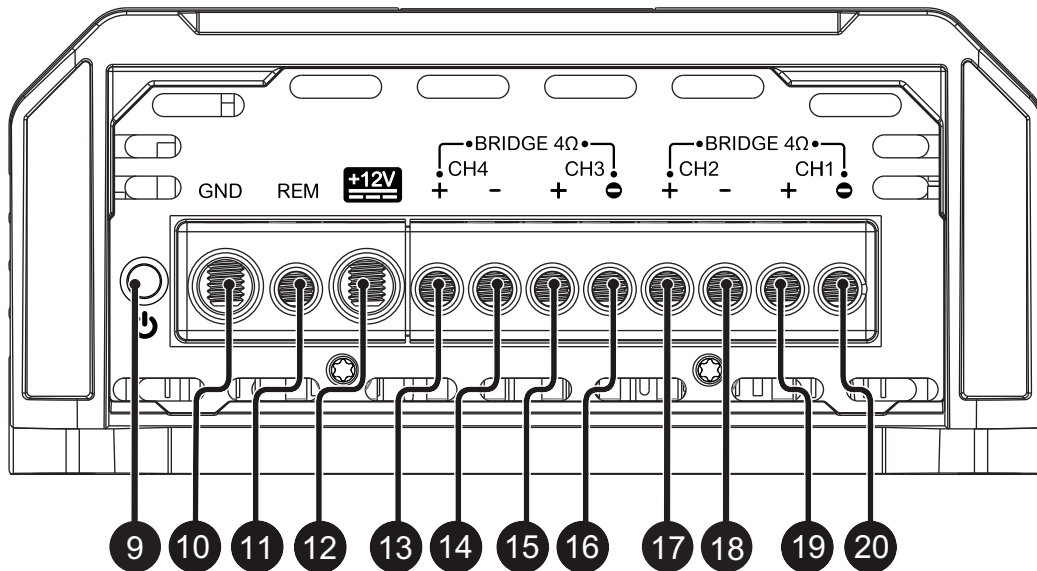

9	-	"POWER ON" LED indicator (Blue)
10	-	Negative power supply connector (GND)
11	-	Remote power supply connector (REM)
12	-	Positive power supply connector (+12VDC)
13	CH4	Positive speaker connector (+)
14	CH4	Negative speaker connector (-)
15	CH3	Positive speaker connector (+)
16	CH3	Negative speaker connector (-)
17	CH2	Positive speaker connector (+)
18	CH2	Negative speaker connector (-)
19	CH1	Positive speaker connector (+)
20	CH1	Negative speaker connector (-)

## ELECTRICAL DIMENSIONING

For proper operation of your SoundDigital amplifier, you need the proper dimensioning of the electrical system and the cables used.

The table below shows the minimum section of GND cables, +12VDC cables and speaker output cables according to the power generated by the amplifier.

600 WRMS	POWER CABLE (+12VDC)	10mm <sup>2</sup> (7 AWG)
	GROUND CABLE (GND)	
	SPEAKER CABLE	2 x 1.5mm <sup>2</sup> (15 AWG)

We recommend the use of ONLY OFC (Oxygen Free Copper) Cables on the installation of our products. CCA cables must not be used.

## AUDIO INPUTS

### RCA inputs

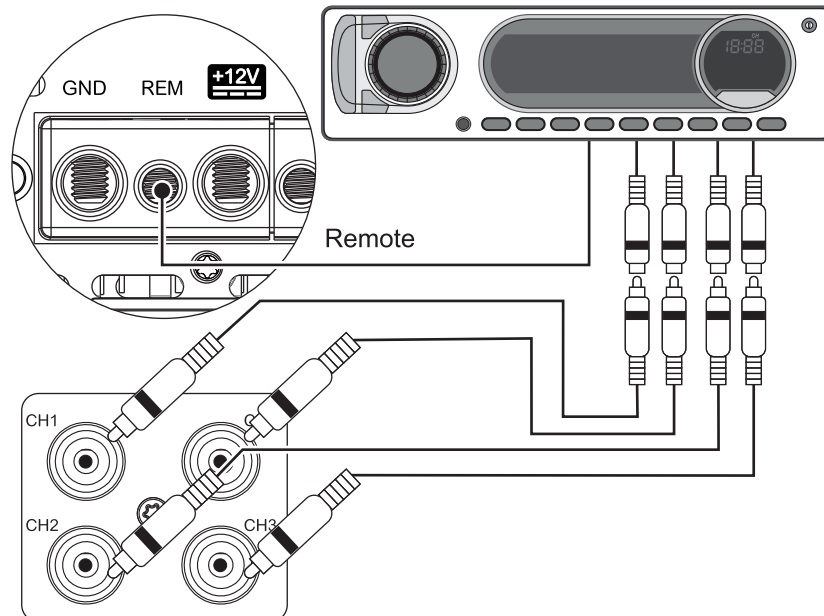

All RCA Inputs must be connected for the all channels to work properly. If the signal source is mono type, use "Y" cable at the input.



**Warning!**

BEFORE PROCEEDING WITH THE INSTALLATION, UNPLUG THE NEGATIVE TERMINAL FROM ALL OF THE BATTERIES, TO AVOID FIRE, DAMAGE TO THE AMPLIFIER AND THE USER HIMSELF.

- Mount the amplifier in such a way you have access to the connectors;
- Install the power cables in the vehicle properly, starting from the battery to the fuse holder or circuit breaker, use the cable with the appropriate size. Make all connections, install fuse holders or circuit breakers, but without placing the fuses or with the circuit breakers in the "OFF" position;

**Warning!**

THE MAXIMUM DISTANCE FOR THE INSTALLATION OF THE FUSE/CIRCUIT BREAKER IS 12 INCHES (30cm) AWAY FROM THE BATTERY.

- Connect the power cables in to the amplifier, observing the polarity. Connect all the positive cables from the fuse holder or circuit breaker to the positive connector of the amplifier and all the negative power cables from the batteries to the negative connector of the amplifier;
- The ground cable must be as short as possible and must be connected to the vehicle chassis and the battery negative;

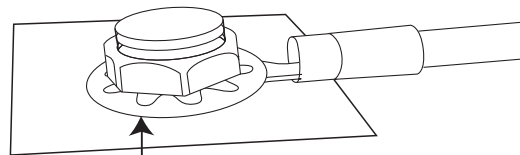

Remove the paint between the terminal and chassis

- Install the signal input cables in a proper way, distant from the power cables;
- Connect the RCA or the high level signal input cables to the head unit and amplifiers;
- Install the audio output cables with the appropriate section, distant from the power and audio input cables;
- Connect the audio output cables to the amplifier and speakers respecting the positive (+) and negative (-) polarities;
- Install the remote cable with the power cables, using 1.5mm<sup>2</sup> (15 AWG) cable or thicker;
- Connect the remote power cable to the amplifier's "REM" terminal at the main unit's remote power output (when not using the high level signal inputs);
- Before powering the system, verify all the connections and make sure there are no mistakes or short-circuits on the power and ground cables;
- Reconnect the ground of the batteries;
- Check if the head unit is turned off and then place the fuses in the fuse holders or switch the circuit breakers on;
- Turn on the main unit and the amplifier will turn on the "POWER ON" LED indicating that it is in operation.

### 4 CHANNELS WIRING DIAGRAM

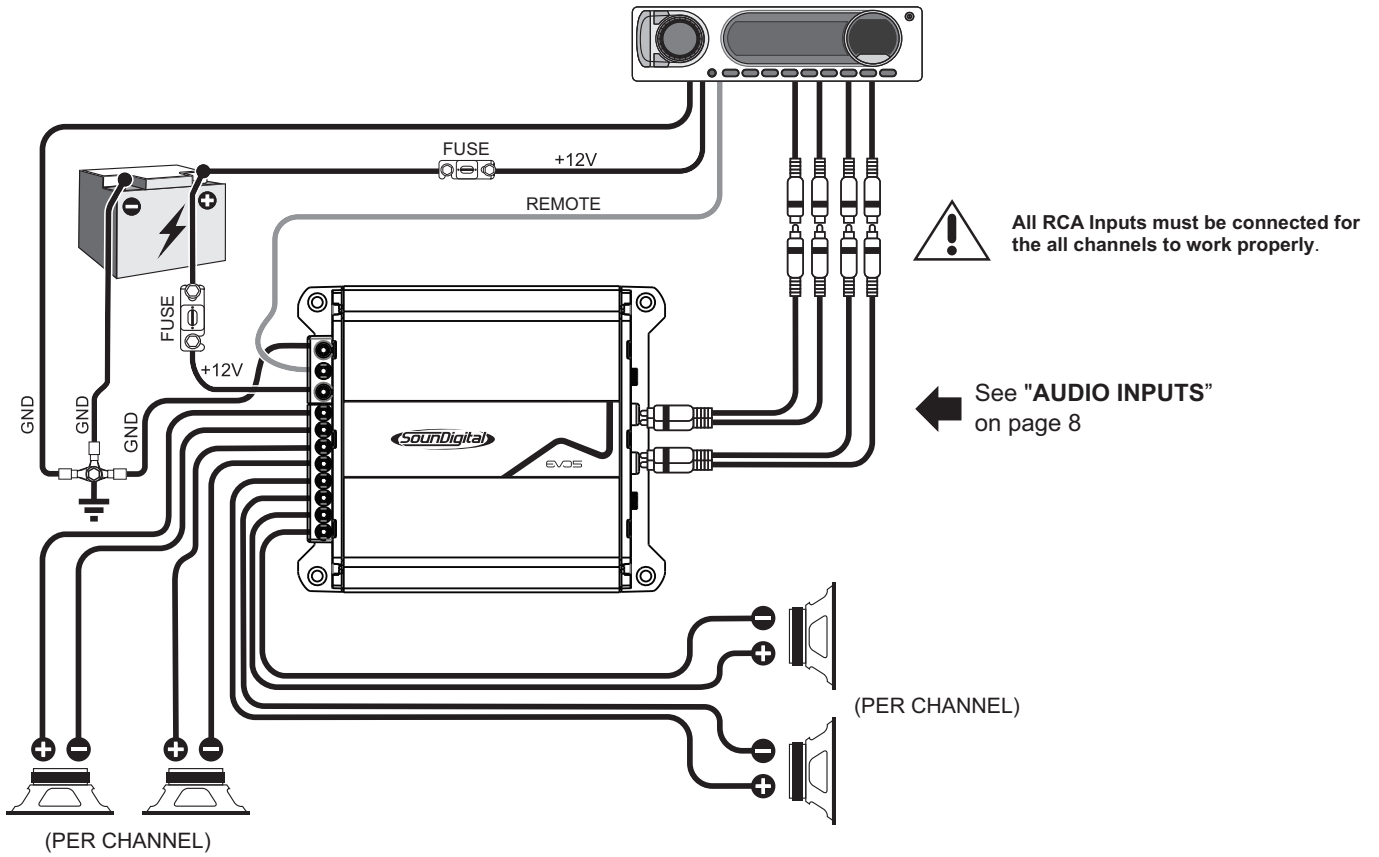

Model	Minimum impedance of use according to the model	
	Per channel	Bridge
600.4 EVOS 40	2Ω	4Ω

### 3 CHANNELS WIRING DIAGRAM

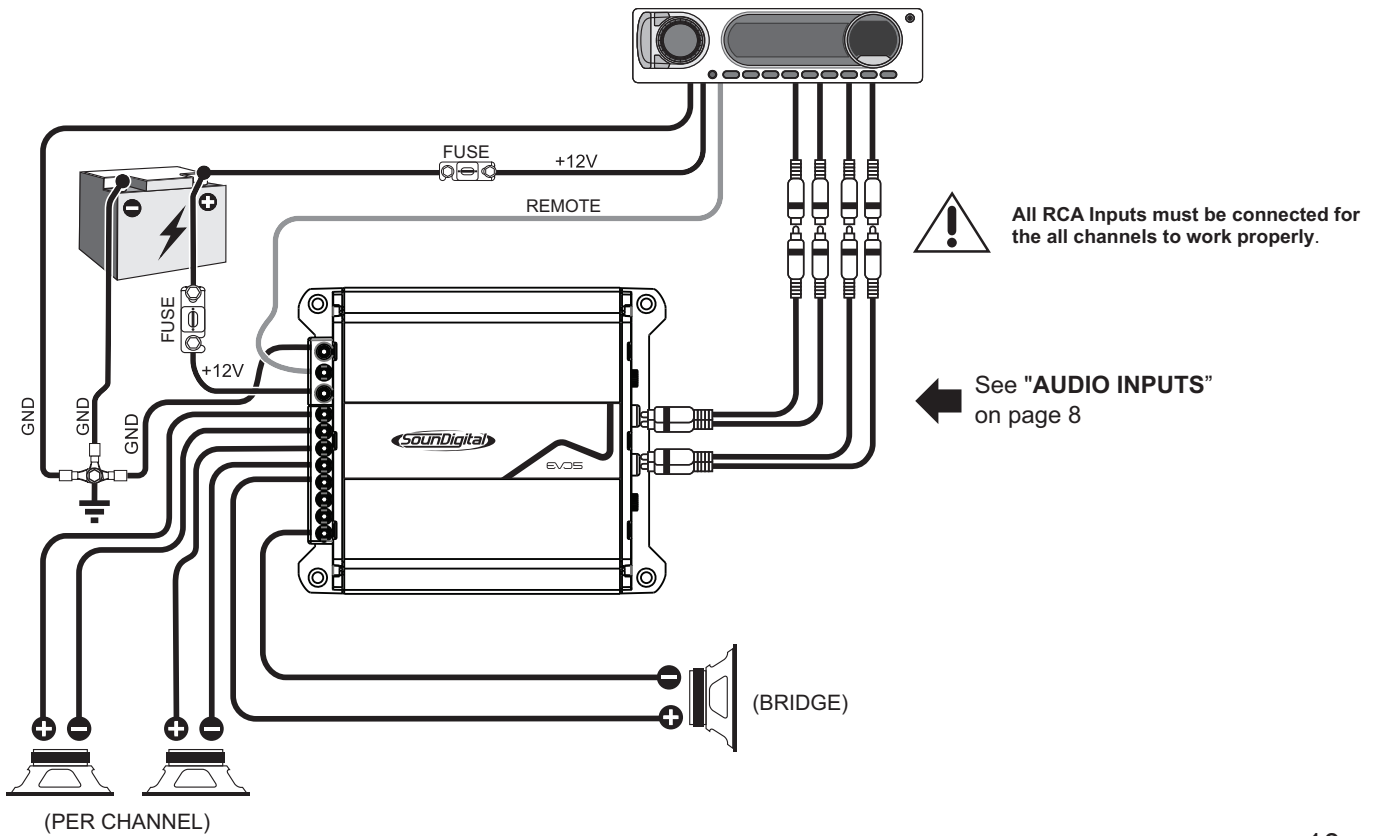

## 2 CHANNELS WIRING DIAGRAM (BRIDGE)

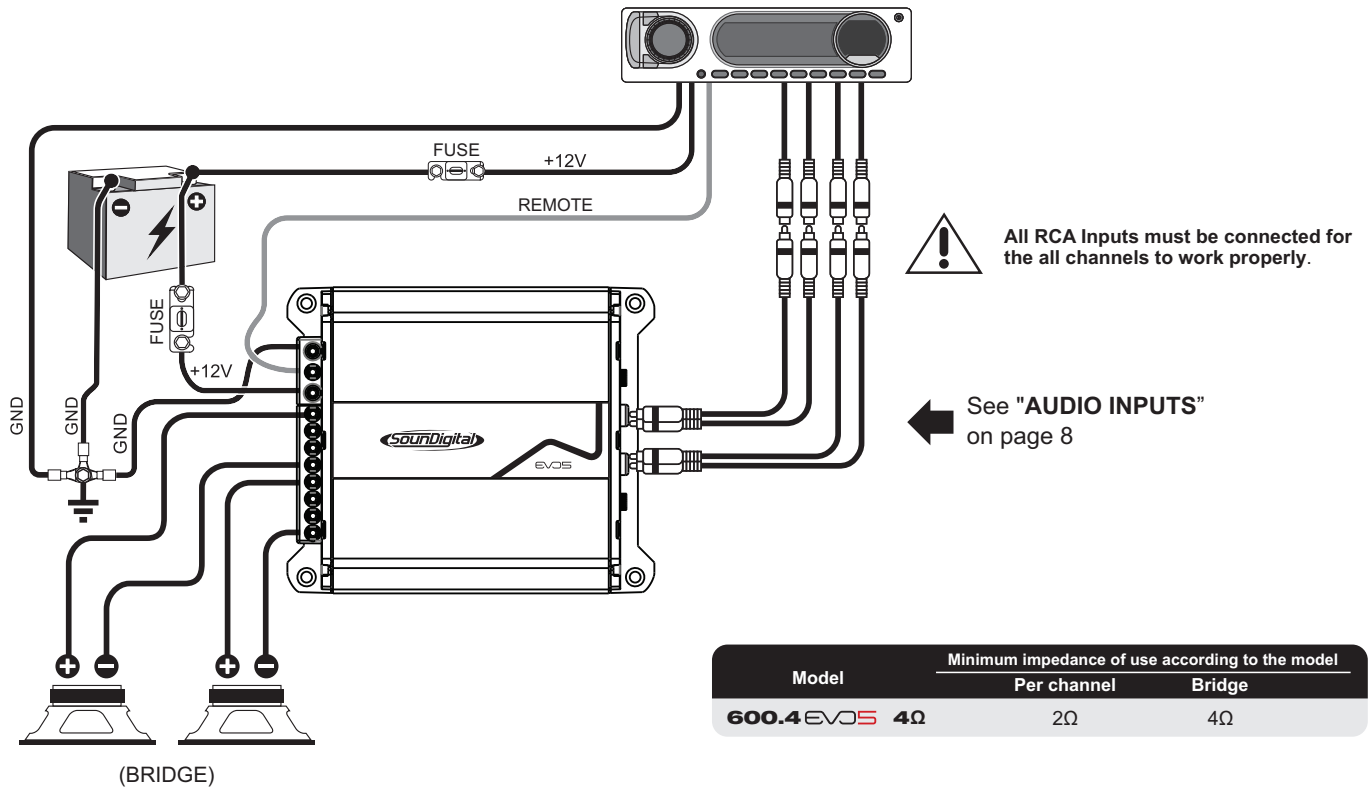

## GAIN SETTING

### Necessary equipment:

- Digital AC voltmeter;
- Media with sine wave test tone 60Hz recorded at 0db.

### Set up procedure:

- This procedure is the same for both gain controls;
- Turn the gain control all the way down;
- Disconnect the output cables from the amplifier outputs;
- Turn off all processing (bass, treble, loudness, EQ, etc.);
- Set the source unit volume to 3/4 of full volume;
- On the audio player, set the fader control to center position;

- Set the crossover selector switch in "F";
- Use a 60Hz sine wave;
- Connect the AC voltmeter to the speaker output connectors of the amplifier. Make sure you test the voltage at the correct connectors (+ and -);
- Increase the gain control until the target voltage is observed with the voltmeter (see the chart below);
- Once you have adjusted the amplifier to its correct voltage output, turn off the source unit and reconnect the speaker(s).

Download the tracks for set up in <https://sounddigitalusa.com/tracks-for-set-up/>

MODEL	STEREO / POWER	BRIDGE / POWER	STEREO OUTPUT VOLTAGE	BRIDGE OUTPUT VOLTAGE
600.4EVO5 4Ω	2Ω/ 4x150W	4Ω/ 2x300W	17,32V	34,64V

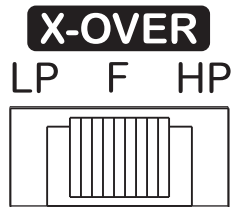

- "F" All the frequencies will be reproduced
- "LP " Frequencies below 80Hz will be reproduced
- "HP " Frequencies above 80Hz will be reproduced

➤ Change the switch to "F" position (Full Range) - All the frequencies will be reproduced.

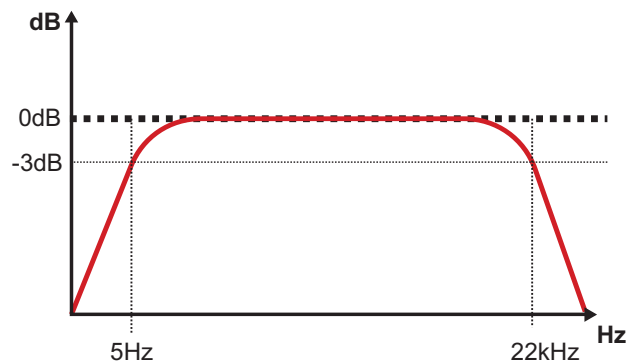

➤ Change the switch to "HP" position - All frequencies above 80Hz will be reproduced as in "Figure 2";

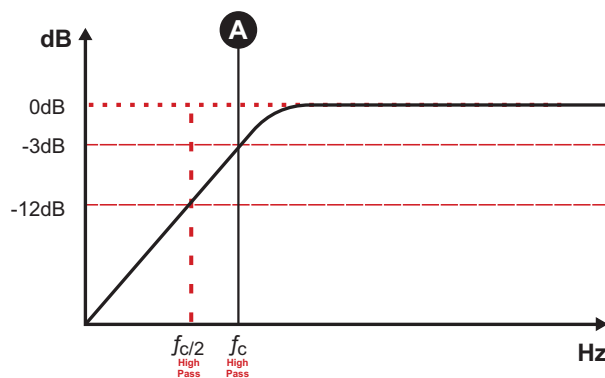

➤ Change the switch to "LP" position - All frequencies below 80Hz will be reproduced as in "Figure 3".

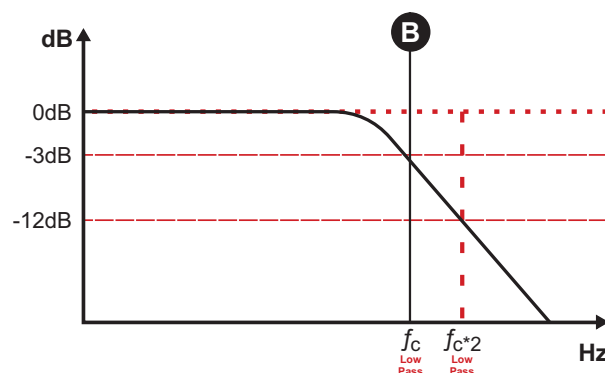

PARAMETERS	600.4 EVOS 4Ω
Power RMS @ 4Ω**	4 x 100W
Power RMS @ 2Ω**	4 x 150W
Power RMS (Bridge) @ 8Ω**	2 x 198W
Power RMS (Bridge) @ 4Ω**	2 x 300W
Frequency Response (-3dB)	10Hz ~ 20kHz
Low Pass filter (12dB/octave)	80Hz
High Pass filter (12dB/octave)	80Hz
Operating Voltage	8V ~ 16V
SNR	88dB
Input Sensitivity (RCA)	0.2V ~ 2V
Current Draw (music)	27A
Current Draw (max.)	54A
Total Efficiency	88%
Damping Factor (@100Hz nominal impedance)	200
Power Cable	10mm <sup>2</sup> (7 AWG)
Speaker Cable	2 x 1.5 mm <sup>2</sup> (15 AWG)
Recommended Fuse* (music)	40A
Recommended Battery (minimum)	40Ah

\*It is mandatory to install the fuse at a maximum distance of 12 inches from the battery.

\*\*Power at 12.6V @ 60Hz with a maximum THD of 1%.



**\*\*POWER RATING ACCORDING TO CTA-2006 INDUSTRY STANDARDS**

## DIMENSIONAL DATA

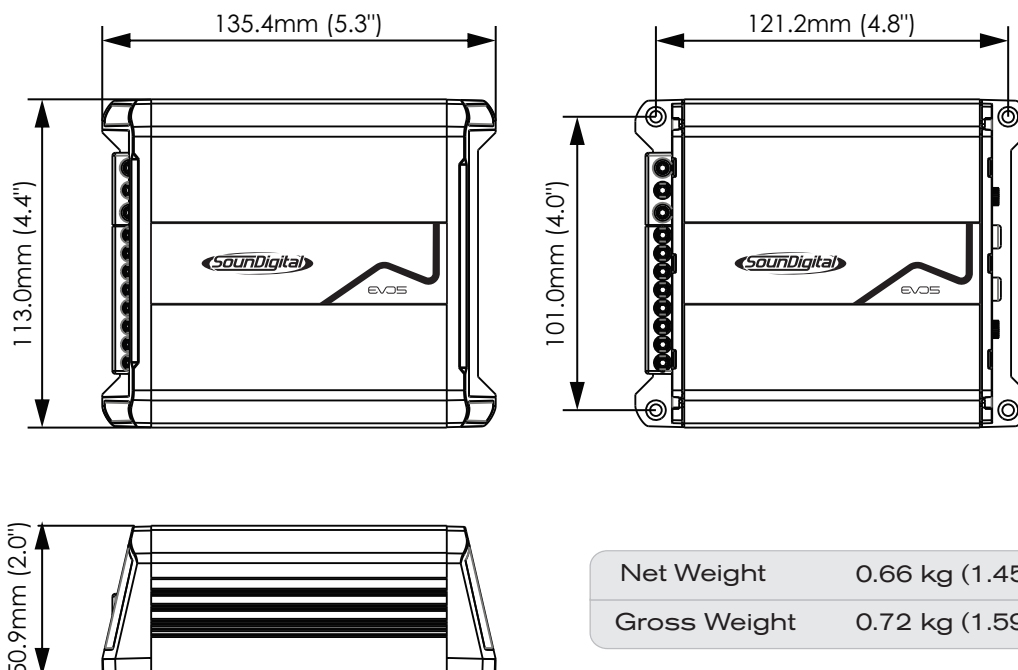

Net Weight 0.66 kg (1.45 lb)

Gross Weight 0.72 kg (1.59 lb)



YOUR MUSIC. **YOUR POWER.**

CODE.: 1000750321-001/DEC2022



Consumer  
Technology  
Association™



[WWW.SOUNDIGITALUSA.COM](http://WWW.SOUNDIGITALUSA.COM)



[SOUNDIGITALUSA](https://www.facebook.com/SOUNDIGITALUSA)



[SOUNDIGITALUSA](https://www.instagram.com/SOUNDIGITALUSA)